



Room thermostat with KNX communications

RDG400KN

For VAV heating and cooling systems

- **KNX bus communications (S-mode and LTE mode)**
- **Backlit display**
- **PI / P control**
- **Output for VAV box / damper: DC 0...10 V / 3-position / KNX LTE mode**
- **Output for heating / cooling coil: ON/OFF, PWM or 3-pos / DC 0..10V**
- **Output signal inversion as an option (DC 0...10 V → DC 10...0 V)**
- **2 multifunctional inputs for keycard contact, external sensor, etc**
- **Operating modes: Comfort, Economy and Protection**
- **Control depending on the room or the return air temperature**
- **Supply fan optimization: Input DC 0...10 V for damper position feedback**
- **Automatic or manual heating / cooling changeover**
- **Minimum and maximum limitation of room temperature setpoint**
- **Minimum and maximum limitation of air flow signal**
- **Adjustable commissioning and control parameters**
- **Commissioning with Synco ACS700, ETS3 Professional or via local HMI**
- **Integration into Synco**
- **Integration into DESIGO via group addressing (ETS3) or via individual addressing**
- **Integration into third-party system via group addressing (ETS3)**
- **Operating voltage AC 24 V**

Edition 2.0

CE1N3192en
05 Dec 2011

Building Technologies

The RDG400KN room thermostat is designed for the following types of system:

VAV systems via ON/OFF or modulating control outputs or KNX LTE-Mode:

- Single-duct system
- Single-duct system with electric heater
- Single-duct system and radiator / floor heating
- Single-duct system with heating / cooling coil

The room thermostat is delivered with a fixed set of applications.

The relevant application is selected and activated during commissioning using one of the following tools:



- Synco ACS
- ETS3 Professional (planned)
- Local DIP switch and HMI

Functions

- Room temperature control via built-in temperature sensor or external room temperature / return air temperature sensor
- Changeover between heating and cooling mode (automatic via local sensor or bus, or manual)
- Selection of applications via DIP switches or commissioning tool (ACS700, ETS3 Professional)
- Select operating mode via operating mode button on the thermostat
- Temporary Comfort mode extension
- Display of current room temperature or setpoint in °C and/or °F
- Minimum and maximum limitation of room temperature setpoint
- Minimum and maximum limitation of air flow signal DC 0...10 V
- Button lock (automatic or manual)
- 2 multifunctional inputs, freely selectable for:
 - Operating mode switchover contact (keycard, window contact, etc.)
 - Changeover sensor for automatic heating / cooling mode
 - External room temperature or return air temperature sensor
 - Dewpoint sensor
 - Electric heater enable
 - Faults
 - Monitor input for temperature sensor or switch status
- Optimization of the pressure control using
 - feedback of the damper position and the present air flow value via KNX bus
 - or feedback of the damper position via a DC 0...10V input
- Floor heating temperature limit
- Reload factory settings for commissioning and control parameters
- KNX bus (terminals CE+ and CE-) for communication with Synco or KNX compatible devices
- Display of outside temperature or time of day via KNX bus
- Time scheduling and central control of setpoints via KNX bus
- A RMB7xx / RMU7xx controller (signal exchange over KNX) uses:
 - the air demand signal of the thermostat to optimize supply air temperature.
 - the energy demand signals of the heating / cooling device to optimize energy supply.
 - the damper position feedback (DC 0...10 V or KNX) to optimize supply fan speed.

Applications

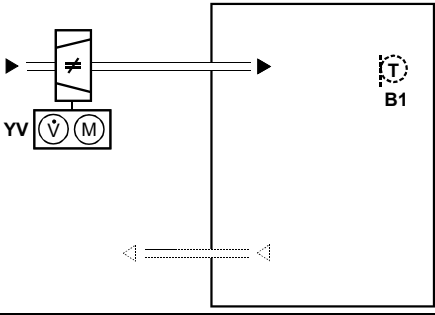
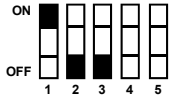
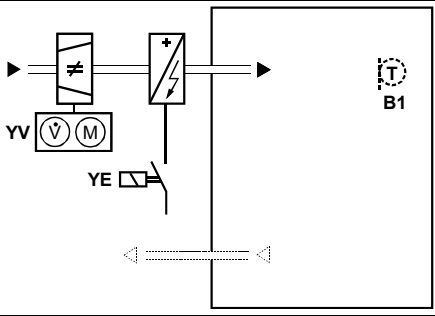
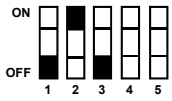
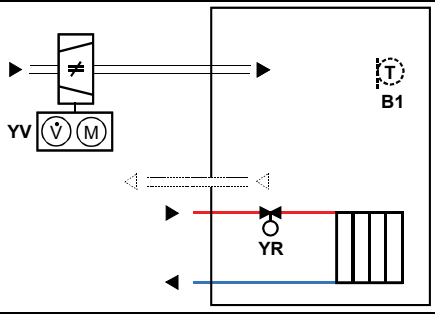
The thermostat supports the following applications, which can be configured using the DIP switches at the rear of the unit or a commissioning tool.
DIP switches 1...3 need to be set to OFF (remote configuration, factory setting) to select an application via commissioning tool.

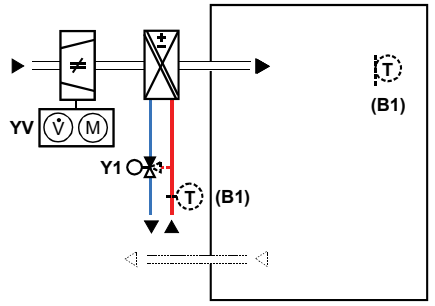
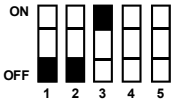
Application	DIP switches
Remote configuration via commissioning tool (factory setting) <ul style="list-style-type: none"> • Synco ACS • ETS3 professional (planned) 	
Single-duct <ul style="list-style-type: none"> • DC 0...10 V damper actuator (P47 = 0) • 3-position damper actuator (P47 = 1) • VAV compact controller with KNX LTE mode 	
Single-duct with electric heater <ul style="list-style-type: none"> • DC 0...10 V damper actuator and ON/OFF, PWM or 3-position electric heater (P47 = 0) • 3-position damper actuator and DC 0...10 V electric heater (P47 = 1) • VAV compact controller with KNX LTE mode and electric heater 	
Single-duct and radiator / floor heating <ul style="list-style-type: none"> • DC 0...10 V damper actuator and ON/OFF, PWM or 3-position radiator (P47 = 0) • 3-position damper actuator and DC 0...10 V radiator (P47 = 1) • VAV compact controller with KNX LTE mode and radiator 	
Single-duct heating and cooling coil <ul style="list-style-type: none"> • DC 0...10 V damper actuator and ON/OFF, PWM or 3-position heating and cooling (P47 = 0) • 3-position damper actuator and DC 0...10 V heating and cooling (P47 = 1) • VAV compact controller with KNX LTE mode and heating / cooling coil 	

Note Use P47 to change damper output from DC 0...10 V (factory setting) to 3-position
 Use P46 to change valve output from ON/OFF (factory setting) to PWM
 Use DIP switch 5 to change valve output from ON/OFF to 3-position

Type summary

Typ	Stock number	Features						Backlit LCD
		Operating voltage	Number of control outputs					
			ON/OFF	PWM	3-pos	DC 0...10 V	KNX LTE-Mode	
RDG400KN	S55770-T165	AC 24 V	1 ¹⁾	1 ¹⁾	1 ¹⁾	1	1	✓

1) ON/OFF, 3-position or PWM











Ordering

Product number	Stock number	Designation
RDG400KN	S55770-T165	Room thermostat















Order valve actuators separately.

Equipment combinations

DC 0..10 V actuators

Type of unit		Product no.	Data sheet
Cable temperature sensor		QAH11.1	1840
Room temperature sensor		QAA32	1747
Condensation detector / Supply unit		QXA2000 / QXA2001 / AQX2000	1542
Electrical actuator, DC 0..10 V (for radiator valve)		SSA61...	4893
Electrical actuator, DC 0..10 V (for 2 and 3 port valves / V...P45)		SSC61...	4895
Electrical actuator, DC 0..10 V (for small valve 2,5 mm)		SSP61...	4864
Electrical actuator, DC 0..10 V (for small valves 5.5 mm)		SSB61...	4891
Electrical actuator, DC 0..10 V (for Combi-valve VPI45)		SSD61...	4861
Thermal actuator, DC 0..10 V (for small valves and radiator valves)		STS61	4880
Electromotoric actuator, DC 0..10V (for valves 5.5 mm)		SQS65...	4573

DC 0...10 V and 3-pos
damper actuators and
VAV compact controllers

Type of unit		Product no.	Data sheet	
DC 0...10 V damper actuator		GQD161...	4605	
		GDB161...	4634	
		GLB161...		
		GMA161...	4614	
		GEB161...	4621	
		GCA161...	4613	
		GBB161...	4626	
		GIB161...		
	VAV compact controller		GDB181.1E/3	3544
GLB181.1E/3				
VAV compact controller for KNX LTE mode		GDB181.1E/KN	3547	
		GLB181.1E/KN		
ON/OFF actuators AC 24 V	Electromotoric ON/OFF valve and actuator (only available in AP, UAE, SA and IN)		MVI.../MXI...	4867
	Electromotoric ON/OFF actuator		SFA71...	4863
ON/OFF / PWM actuators AC 24 V *)	Thermal actuator (for radiator valve)		STA71...	4877
	Thermal actuator (for small valves 2.5 mm)		STP71...	4878
3-position actuators AC 24 V	Electrical actuator, 3-position (for radiator valve)		SSA81...	4893
	Electrical actuator, 3-position (for small valve 2,5 mm)		SSP81...	4864
	Electrical actuator, 3-position (for small valve 5,5 mm)		SSB81...	4891
	Electrical actuator, 3-position (for Combi-valve VPI45)		SSD81...	4861
	Electromotoric actuator, 3-position (for valves 5.5 mm)		SQS85...	4573

*) With PWM control, it is not possible to ensure exact parallel running of more than one thermal actuator. If several actuators are controlled by the same room thermostat, preference should be given to motorized actuators with ON/OFF or 3-position control.

Description	Product no. / stock no.	Data sheet
Changeover mounting kit (50 pcs / package)	ARG86.3	N3009
Adapter plate 120 x 120 mm for 4" x 4" conduit boxes	ARG70	N3009
Adapter plate 112 x 130 mm for surface wiring	ARG70.2	N3009
KNX Power supply 160 mA (Siemens BT LV)	5WG1 125-1AB01	--
KNX Power supply 320 mA (Siemens BT LV)	5WG1 125-1AB11	--
KNX Power supply 640 mA (Siemens BT LV)	5WG1 125-1AB21	--

Mechanical design

The room thermostat consists of 2 parts:

- Plastic housing with electronics, operating elements and room temperature sensor
- Mounting plate with screw terminals

The housing engages in the mounting plate and is secured with 2 screws.

Operation and settings

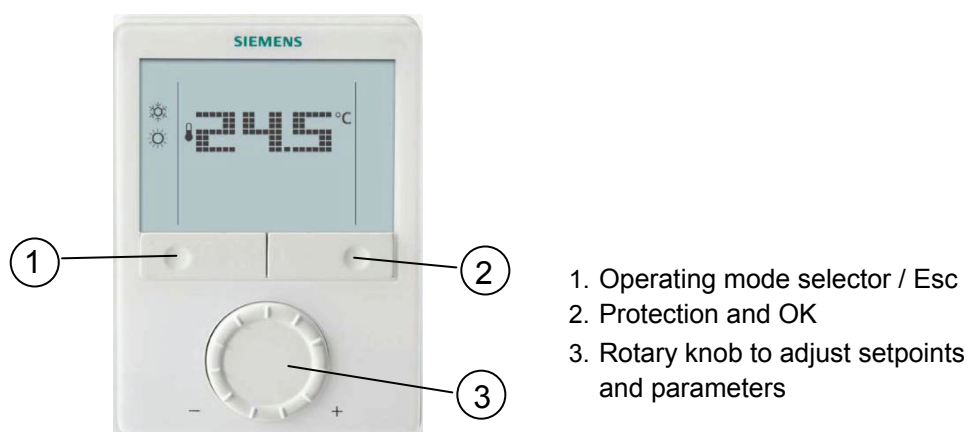

Display

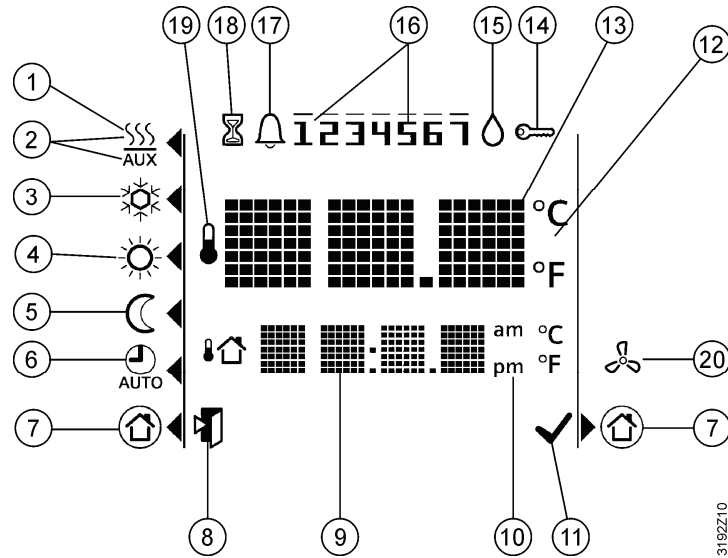

#	Symbol	Description	#	Symbol	Description
1		Heating mode	11		Confirmation of parameters
2		Heating mode, electric heater active	12		Degrees Celsius Degrees Fahrenheit
3		Cooling mode	13		Digits for room temperature and setpoint display
4		Comfort	14		Button lock active
5		Economy	15		Condensation in room (dewpoint sensor active)
6		Auto Timer mode according to schedule (via KNX)	16		Weekday 1...7 from KNX bus 1 = Monday / 7 = Sunday
7		Protection mode	17		Fault
8		Escape	18		Temporary timer function; visible when operating mode is temporarily extended (extended presence or absence)
9		Additional user information, like outdoor temperature or time of day from KNX bus. Selectable via parameters	19		Indicates that room temperature is displayed
10		Morning: 12-hour format Afternoon: 12-hour format	20		Primary fan is active (only supported with Synco700 primary controller)

Engineering notes

See the "Reference documentation", page 12 for information on how to engineer the KNX bus (topology, bus repeaters, etc.) and how to select and dimension connecting cables for supply voltage and field devices.

Mounting and installation

Do not mount on a wall in niches or bookshelves, behind curtains, above or near heat sources, or exposed to direct solar radiation. Mount about 1.5 m above the floor.

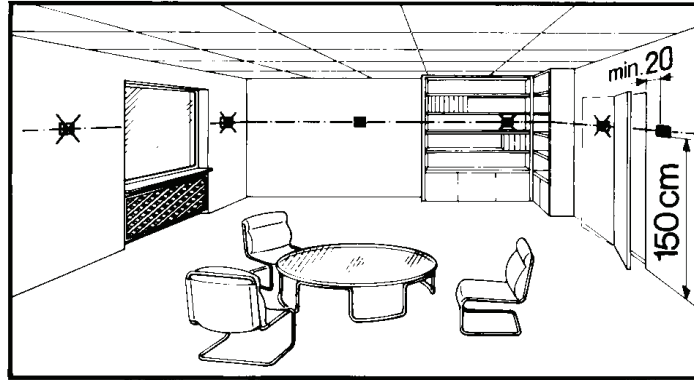

Mounting



- Mount the room thermostat on a clean, dry indoor place without direct airflow from a heating / cooling device, and not exposed to drips or splash water.

Wiring

See the mounting instructions M3192 enclosed with the thermostat.



- Comply with local regulations to wire, fuse and earth the thermostat.
- The power supply line must have an external fuse or circuit breaker with a rated current of no more than 10 A.
- Isolate the cables of inputs X1-M, U1-G0 and D1-GND for 230 V if the conduit box carries AC 230 V mains voltage.
- Inputs X1-M or D1-GND: Several switches (e.g. summer/winter switch) may be connected in parallel. Consider overall maximum contact sensing current for switch rating.
- Isolate the cables of KNX communication input CE+ / CE- for 230 V if the conduit box carries AC 230 V mains voltage.
- No cables provided with a metal sheath.
- Disconnect from supply before removing from the mounting plate.

Commissioning notes

Applications

The room thermostat is delivered with a fixed set of applications.

Select and activate the relevant application during commissioning using one of the following tools:

- Local DIP switch and HMI
- Synco ACS
- ETS3 Professional (planned)

Set the DIP switches before snapping the thermostat to the mounting plate, If you want to select an application via **DIP switches**.

All DIP switches need to be set to “OFF” (“remote configuration”), if you want to select an application via **commissioning tool**.

After power is applied, the thermostat resets and all LCD segments flash, indicating that the reset was correct. After the reset, which takes about 3 seconds, the thermostat is ready for commissioning by qualified HVAC staff.

If all DIP switches are OFF, the display reads "NO APPL" to indicate that application commissioning via a tool is required.

Note Each time the application is changed, the thermostat reloads the factory setting for all control parameters, except for KNX device and zone addresses!

Connect tool

Connect the Synco ACS or ETS3 Professional tools to the KNX bus cable at any point for commissioning:

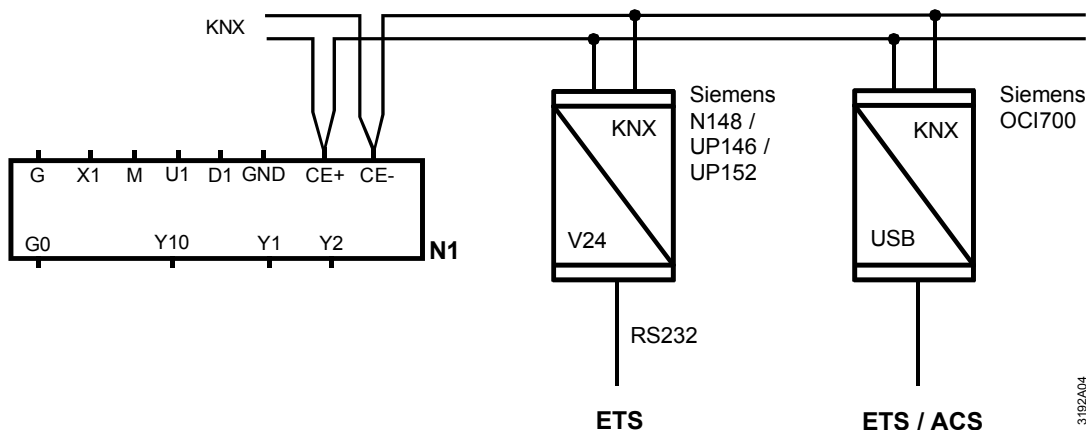

ACS and ETS3 require an interface:

- RS232 KNX interface (e.g. Siemens N148 / UP146 / UP152)
- OCI700 USB-KNX interface

Note An external KNX bus power supply is required if an RDG400KN is connected directly to a tool (ACS or ETS3) via KNX interface.

Control parameters

The thermostat's control parameters can be set to ensure optimum performance of the entire system (see basic documentation P3192).

The parameters can be adjusted using

- Local HMI
- Synco ACS
- ETS3 Professional (planned)

Control sequence

- The control sequence may need to be set via parameter P01 depending on the application. The factory setting is "Cooling only"

Calibrate sensor

- Recalibrate the temperature sensor if the room temperature displayed on the thermostat does not match the room temperature measured (after min. 1 hour of operation). To do this, change parameter P05

Setpoint and setpoint range limitation

- We recommend to review the setpoints and setpoint ranges (parameters P08...P12) and change them as needed to achieve maximum comfort and save energy

Programming mode The programming mode helps identify the thermostat in the KNX network during commissioning.

Press the left and right buttons simultaneously for 6 sec to activate programming mode, which is indicated on the display with "PrO9".
Programming mode remains active until the identification of the thermostat is complete.

Assign KNX group addresses Use ETS3 Professional to assign the KNX group addresses of the RDG communication objects.

KNX serial Number Each device has a unique KNX serial number inside of the plastic housing. An additional sticker with the same KNX serial number is enclosed in the packaging box. This sticker is intended for installers for documentation purposes.

Disposal





This device is classified as waste electronic equipment under European Directive 2002/96/EC (WEEE) and may not be disposed of as unsorted municipal waste. Adhere to all relevant national laws. Regarding disposal, use the systems setup for collecting electronic waste. Observe all local and applicable laws.

Technical data

⚠ Power supply	Operating voltage	SELV AC 24 V ±20%
	Rated voltage	AC 24 V
	Frequency	50/60 Hz
	Power consumption	Max. 2 VA / 1 W
Outputs	Control output Y10-G0	DC 0...10 V
	Resolution	39 mV
	Current	Max. ±1 mA
	Control output Y1, Y2-G	AC 24 V
	Rating	Max. 1 A
Inputs	Multifunctional inputs	
	X1-M	
	Temperature sensor input	
	Type	QAH11.1 (NTC)
	Temperature range	0...49 °C
	Cable length	Max. 80 m
	Digital input	
	Operating action	Selectable (NO/NC)
	Contact sensing	DC 0...5 V, max. 5 mA
	Parallel connection of several thermostats for one switch	Max. 20 thermostats per switch. Do not mix with D1!
U1-G0		
Input for actual damper position feedback	DC 0...10 V, max 0.3 mA	
damper position 0% (fully closed)	0...100%	
100% (fully open)		

	D1-GND	Operating action	Selectable (NO/NC)
		Contact sensing	SELV DC 6...15 V, 3...6 mA
		Parallel connection of several thermostats for one switch	Max. 20 thermostats per switch. Do not mix with X1!
		Function of inputs	Selectable
		External temperature sensor, heating/cooling changeover sensor, operating mode switchover contact, dewpoint monitor contact, enable electric heater contact, fault contact, monitoring input	X1: P38 D1: P42
KNX bus		Interface type	KNX, TP1-64 (electrically isolated)
		Bus current	20 mA
		Bus topology: See KNX manual (reference documentation, see below)	
Operational data		Switching differential, adjustable	
		Heating mode (P30)	2 K (0.5...6 K)
		Cooling mode (P31)	1 K (0.5...6 K)
		Setpoint setting and setpoint range	
		☀ Comfort (P08)	21 °C (5...40 °C)
		☾ Economy (P11-P12)	15 °C/30 °C (OFF, 5...40 °C)
		🛡 Protection (P65-P66)	8 °C/OFF (OFF, 5...40 °C)
		Multifunctional inputs X1 / D1	Selectable (0...8)
		Input X1 default value (P38)	1 (Ext. temperature sensor, room or return air)
		Input D1 default value (P42)	3 (Operating mode switchover)
		Built-in room temperature sensor	
		Measuring range	0...49 °C
		Accuracy at 25 °C (after calibration via P05)	< ± 0.5 K
		Temperature calibration range	± 3.0 K
		Settings and display resolution	
		Setpoints	0.5 °C
		Current temperature value displayed	0.5 °C
Environmental conditions		Operation	IEC 721-3-3
		Climatic conditions	Class 3K5
		Temperature	0...50 °C
		Humidity	<95% r.h.
		Transport	IEC 721-3-2
		Climatic conditions	Class 2K3
		Temperature	-25... 60 °C
		Humidity	<95% r.h.
		Mechanical conditions	Class 2M2
		Storage	IEC 721-3-1
		Climatic conditions	Class 1K3
		Temperature	-25... 60 °C
		Humidity	<95% r.h.

Standards and directives	 conformity to EMC directive	2004/108/EC
	 C-tick conformity to EMC emission standard	AS/NZS 61000.6.3: 2007
	 Reduction of hazardous substances	2002/95/EG
General	Product standards	
	Automatic electrical controls for household and similar use	EN 60730–1
	Special requirements for temperature-dependent controls	EN 60730–2-9
	Electronic control type	2.B (micro-disconnection on operation)
	Home and Building Electronic Systems	
	Electromagnetic compatibility	
	Emissions (residential)	IEC/EN 61000-6-3
	Immunity (Industry and residential)	IEC/EN 61000-6-2
	Safety class	III as per EN 60730
	Pollution class	Normal
	Degree of protection of housing	IP30 as per EN 60529
	Connection terminals	Solid wires or stranded wires with wire end sleeves 1 x 0.4...2.5 mm ² or 2 x 0.4...1.5 mm ²
	Note: For sensors on inputs X1, X2, or D1, the cable length is max. 80 m	
Housing front color	RAL 9003 white	
Weight without / with packaging	0.237 kg / 0.360 kg	

Reference documentation	Handbook for Home and Building Control - Basic Principles (www.knx.org/uk/news-press/publications/publications/)
Synco	CE1P3127 Communication via the KNX bus for Synco 700, 900 and RXB/RXL Basic documentation
DESIGO	CM1Y9775 DESIGO RXB integration – S-mode CM1Y9776 DESIGO RXB / RXL integration – individual addressing CM1Y9777 Third-party integration CM1Y9778 Synco integration CM1Y9779 Working with ETS

Connection terminals

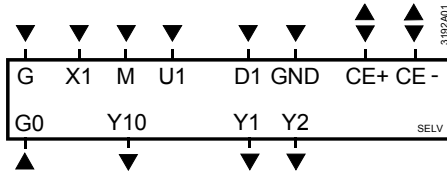

G, G0	Operating voltage AC 24 V
Y10/G0	Control output for DC 0...10 V actuator
Y1/G, Y2/G	Control output for 2-position, PWM or 3-position actuators
X1	Multifunctional input for temperature sensor (e.g. QAH11.1) or potential-free switch Factory setting: external temperature sensor (function can be selected via parameters P38)
M	Measuring neutral for sensors and switches
U1	DC 0...10 V input for actual damper position (Note: G0 is the measuring neutral for U1!)
D1, GND	Multifunctional input for potential-free switch. Factory setting: Operating mode switchover contact (function can be selected via parameters P42)
CE+	KNX data +
CE-	KNX data -

Connection diagrams

Application

Single duct

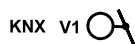
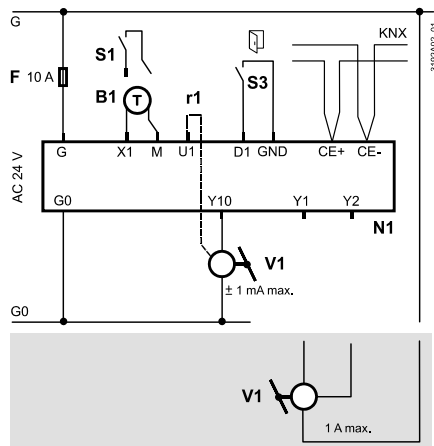

N1	Room thermostat RDG400KN
V1	Damper actuator or VAV compact controller: DC 0...10 V or 3-position, VAV compact controller KNX
V2	Electric heater, radiator or heating / cooling valve: DC 0...10 V, 2-position, PWM or 3-position
S1	Switch (keycard, window contact, etc.)
r1	Feedback signal for actual damper position
S3	Switch at SELV input (keycard, window contact)
B1	Temperature sensor (return air temperature, external room temperature, changeover sensor, etc.)
CE+	KNX data +
CE-	KNX data -

Single-duct with electric heater, radiator or heating / cooling valve

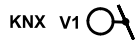
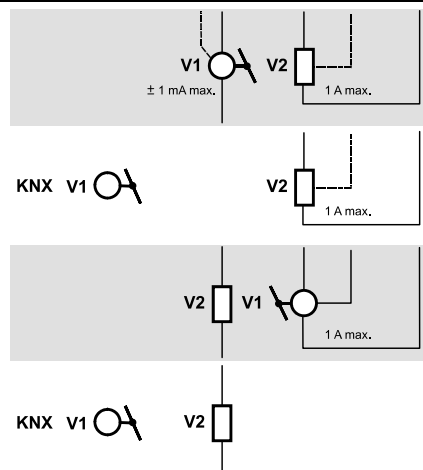

Dimensions

Dimensions in mm

